

# THE WOODTURNERS

ASSOCIATION OF WESTERN AUSTRALIA INC

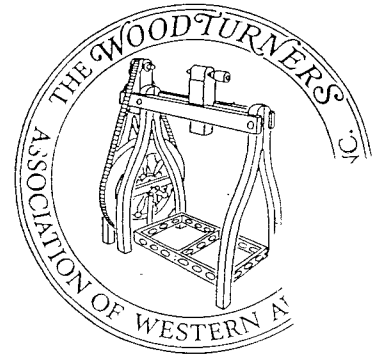

SHOPPING CENTRE DISPLAYS .....	2	NATIONAL COMPETITION .....	5
WEEK END CALENDAR .....	2	MEMBERSHIP SURVEY RESULTS .....	5
KALGOORLIE CENTENARY CELEBRATIONS ...	2	IDEAS FROM KRANDA QLD .....	6
WORKSHOP MEETING APRIL .....	3	AIR BRUSHING CLASSES .....	6
WORKSHOP MEETING MAY .....	3	SAFETY HINTS .....	7
COMPETITIONS JANUARY & FEBRUARY .....	4	WAWA GROUP MEETING DATES .....	7
SHAVINGS FROM THE COMMITTEE .....	4	WAWA COMMITTEE & CONVENORS .....	7

No: 45

APRIL - MAY 1993

SURFACE  
MAIL

POSTAGE  
PAID  
AUSTRALIA

RETURN ADDRESS: P.O. BOX 941 WEST PERTH 6872

REGISTERED BY AUSTRALIA POST. PUBLICATION N° 1883

**TOUGH**  
TEL (09) 457 2056

## The Ultimate in Professional Wood Turning Lathes

ORDER NATIONALLY AT LEADING TURNING & POWER TOOL SHOPS.

**STANDARD EQUIPMENT:** Cast Iron ■ Bed ■ Headstock ■ Camlock tailstock ■ 8" R.H. Face plate ■ 3/16" 24 index hole vee belt pulley ■ Matching motor pulley ■ 6" and 12" tool rests ■ Toolrest Bracket ■ Spanner ■ Spurdrive with removable point ■ Tailstock Centre with removable point.

**OPTIONAL EXTRAS:-** ■ Live tailstock cup centre ■ 24" Tool rest ■ Camlock tool rest bracket ■ Cup chuck ■ Pin chuck ■ 1/2" No 2 morse taper drill chuck ■ Three point steady ■ 8" & 6" Face plates with R.H. or L.H. threads ■ 6" & 8" face plates universal (R.H. & L.H. threads) ■ Outrigger attachments ■ Sanding disc ■ 3" & 4 1/2" face plates with or without tapered screws ■ Deep drilling guide (fit tailstock) ■ Deep drilling attachment ■ Predrilled wood, centring points ■ 1 HP motor ■ Lathe stand.

**BENCH LATHE OR FLOOR LATHE**

Camlock tool rest & tailstock

**UNDER NEW MANAGEMENT**  
Manufactured by **F. & R. TOUGH**  
**NORM HOSKIN — 9 AMSTEY STREET RIVERTON, WESTERN AUSTRALIA 6155**

**WOODWORKERS SHED PTY. LTD.**

### WOODTURNING & SUPPLIES

*Supplying Woodies with the Goodies.*

Wood turning blanks from recycled Jarrah.  
Turning Chisels Carving Chisels  
Clock Movements  
Polishes and Sand Papers

**TREVOR FIELDING**  
Unit 3, Savery Way,  
Rockingham, 6168  
**592 2293**

### PRESIDENT'S COMMENTS.

One of the items dealt with at the last committee meeting was a letter from the Oklahoma Woodturners' Association seeking fellowship with our Association. This brings into closer focus the universality of our craft, and the prospects for widening our circle of friendship. We have already enjoyed meeting Michael Hosaluk from Canada, as well as our friends from Sydney and Melbourne and in April we will be embarking on another style of workshop weekend – a joint venture with the Woodturners of Denmark. It is unlikely that many of us would have met these folk, except via the link of our Association, and the prospects for extending the links are endless.

On a more personal note, I too have enjoyed the widening circle of friends who greet me at meetings and phone me at home. If I haven't appeared to play a very active role since assuming the office of President, it's only because the various sub-committees, organisers and convenors have kept things running so smoothly. I thank you all and look forward to a closer association in the future.

Jon Croft.

\*\*\*\*\*

### SHOPPING CENTRE DATES AND DISPLAYS.

WOODBIDGE EASTER FAIR. Ford Street, West Midland. **11-12th April.**

MEN OF THE TREES FIELD DAY. St Barbe Grove; Lot 2 Stirling Court, Hazelmere. **1st May.**

PHOENIX SHOPPING CENTRE. Rockingham Road, Spearwood. **24-29th May.**

Contacts: John Lillywhite (09) 339 2359  
Neil Basden (09) 349 1082  
Len Nicholls (09) 339 6490

\*\*\*\*\*

### INVITATION.

The Kenwick Group have recently completed an extension to their Club Room at the Liddelow Pioneer Homestead Art and Craft Centre, Cooper Avenue, Kenwick. The members did the construction work and the Homestead Committee/Gosnells Council provided the funds. The Group extends a warm invitation to WAWA members and their partners to join them at an **OPEN DAY** at their Clubrooms in the afternoon on **SATURDAY, 24th APRIL, 1993 from 2 to 5pm** when there will be an opportunity to visit the well stocked Craft Shop. As they will be providing light refreshments, they would much appreciate a ring from those intending to be there. Alf Valentine. (09) 399 7771

\*\*\*\*\*

### CORRECTION AND APOLOGY.

In our last newsletter, Issue 44, we incorrectly reported that Brian Launer won the Shire of Denmark Award at the recent Woodturners of Denmark Annual Award Exhibition. This award was **shared equally** between Brian Launer and Andrew Marshall. Sorry Andrew. Editor.

\*\*\*\*\*

**CONGRATULATIONS** to Bert McDonough, Melville's oldest member who recently featured in an article on Woodturning in both the Canning Melville Times and the Fremantle Gazette, publications by Community Newspapers.

### ASSOCIATION WEEKEND CALENDAR.

Date: **17th/18th April, 1993.**  
Venue: Denmark Agricultural High School, Denmark.  
Competition: Any turned piece made for artistic or aesthetic appeal (ie not necessarily functional). Judged by a panel of judges.  
Host Group: Woodturners of Denmark and the WA Coord Committee jointly.

Date: **15th/16th May, 1993.**  
Venue: Mandurah High School, Gibla Street, Mandurah.  
Competition: Inside out turned form, any size.  
Host Group: Mandurah.

Date: **19/20th June, 1993.**  
Venue: Loftus Community Centre, Cnr Loftus and Richmond Street, Leederville.  
Competition: Mug Tree, spindle turned except for base, which may be spindle or face plate.

Beginners: Four Mugs.  
Intermediates: Six Mugs.  
Open: More than six mugs.  
Host Group: North of River Group.

Date: **17/18th July, 1993.**  
Venue: Brown Park Pavilion, Amhurst Road, Swan View.  
Competition: Pomander. (Drawing supplied in next Newsletter).  
Host Group: Midvale.

\*\*\*\*\*

### KALGOORLIE CENTENARY CELEBRATIONS.

**14th/19th JUNE, 1993.**

Present indications are that 10 members will be going to Kalgoorlie to participate in the Woodline Festival. Generally, members are making their own transport and accommodation arrangements. It is hoped that members travelling alone will get together to reduce costs and the boredom of a long road journey.

Local members Peter McGinty and Peter Grainger will be co-ordinating the Kalgoorlie programme. For further details, contact Milton Rundle on (09) 385 9559.

\*\*\*\*\*

### DENMARK ACCOMMODATION NOTE.

Accommodation bookings with meals at the Agricultural High School closed at the end of March to meet the School's planning requirements. However, there is ample accommodation in Denmark within easy distance of the School. Information on the wide range of options, is available from the Denmark Tourist Bureau. They will assist in making bookings. Phone (098) 481265.

\*\*\*\*\*

**FOR SALE.** One WOODFAST long bed planing machine, 6" wide cut, 4ft long cast iron tables, tilting fence, 3 blade cutter, 3/4 HP 3 phase motor. \$550 ONO. Phone: (09) 399 5002.

\*\*\*\*\*

**W.A.W.A. WORKSHOP MEETING 17/18th APRIL, 1993.  
DENMARK AGRICULTURAL HIGH SCHOOL,  
DENMARK. 6333.**

On the left, 1km out of Denmark on the road to Albany. This weekend is being run in conjunction with the WOODTURNERS OF DENMARK INC. The ladies programme will be announced each day. The outings available may include a river trip, visits to a Winery, Alpaca Farm and Craft galleries.

**Saturday.**

8.00am Fellowship and Registration.  
8.45 Opening by Jon Croft and Andrew Marshall.  
9.00 Spiral Fluting - Ken Rex.  
9.45 Photographing Work - Graham Rhind.  
10.15 MORNING TEA  
10.45 "Ultra Thins" - Gordon Ward.  
11.30 Heat Shaping Bowls by Steaming - Les Dean and Andrew Marshall.  
12.00 Competition voting opens.  
12.15pm LUNCH. **BYO OR SCHOOL DINING ROOM, if booked in advance.**  
  
1.15pm Inside Out Turning - Jon Croft.  
2.00 Ring Turning - Graham Rhind.  
2.45 Power Carving - Gordon Ward.  
3.00 AFTERNOON TEA  
3.45 Fretwork Mirror - Andrew Marshall.  
4.15 Offset Turning - To be advised.  
5.00 Stone Turning - Glyn Harrington.  
6.15 EVENING MEAL. **SCHOOL DINING ROOM if booked. (Limit 90 people).**  
  
7.30 Denmark Turners critique of their work.  
8.15 Finishing Forum (WAWA and Denmark Turners). Panel of Turners who will each speak briefly on their views and favourite methods of finishing. This will be followed by questions and comments from the audience.  
9.30pm Approx. Close.  
**Sunday.**  
9.00am Multiple bowls to save wood - Les Dean.  
9.30 Vacuum Chucks - Keith Johnson.  
10.15 MORNING TEA  
10.45 Ornamental Turning - Dean Malcolm.  
11.30 Load lathes and clean up.  
12.15pm LUNCH.  
  
1.30pm Competition Results. Show and Tell. President's Forum. Closing remarks.  
3.00 Clean up and pack up.  
\*\*\*\*\*

**W.A.W.A. WORKSHOP MEETING 15/16th May, 1993.  
MANDURAH HIGH SCHOOL, GIBLA STREET,  
MANDURAH.**

The Woodcarvers of Denmark will conduct demonstrations and hands on throughout Saturday and Sunday.

**Saturday.**

8.00am All hands unload chuck wagon and lathe.  
9.00 Registration and fellowship.  
9.30 MORNING TEA.  
10.00 Main Demonstration: Router lathe - Spiral Turning with Dick Morley.  
10.00 Other Demonstrations: Home made Chisels - Col Richards. A \$20 Bandsaw - Fred Lauritsen.

10.00am **Ladies.**  
Making raffia hats with Raina Neal. Ladies wishing to make hats for themselves will be required to pay cost of materials, at present est. at \$12-\$15. Advise workshop coordinator approx. 2 weeks beforehand if raffia required to ensure stocks available, or BYO raffia 300-400 grams.  
11.00 Main Demonstration: Stone turning with Glyn Harrington. Other Demonstration: Spirography with Bill Harrison.  
12.00 LUNCH. **BYO.**  
  
1.00pm Main Demonstration: An update on doughnut turning with Viv Paust.  
Other Demonstration: Hands On with Bill Dicker and Ray Quadrio.  
1.30 **Ladies.**  
Excursion by bus to Dawesville Cut, Threfall Gallery, Murray Arts and Crafts Centre, Edenvale, Pinjarra. Approx 3 hours.  
2.00 Main Demonstration: Tempering Metals, Bandsaws - Joining Blades and mtce - Gordon Ward.  
Other Demonstration: Offset turned serviette holders with Jim Robertson.  
3.00 AFTERNOON TEA.  
3.30 Main Demonstration: An update on finishing with Keith Johnson.  
4.00 Main Demonstration: Basket Weave Techniques with Keith McQueen.  
5.30 CASSEROLE TEA. **BYO.**  
6.30 Show and Tell.  
**Sunday.**  
9.00am Fellowship and hands on with Ray Quadrio and Bill Dicker.  
9.30 MORNING TEA.  
10.00 Designing and making chessmen with the Computerised mini-lathe - Ross Bentley, Mandurah Senior High School.  
11.00 **Ladies.**  
Beadwork with Sue Roach.  
11.00 Demos. A sanding and finishing jig for pedestals - Col Richards. More home made chisels - turning into end grain - Fred Lauritsen. Shellac finishing - Bill Dicker.  
12.00 LUNCH. **BYO.**  
1.00pm President's Forum. Door Prize. Competition Results. Guess the Wood.  
3.00 Clean up, load lathes and chuck wagon.

**IMPORTANT FOOTNOTES:**

- WOODCARVERS.** Bill Van Ravenstein and Bob Mahoney will be carving and in attendance all weekend. They invite all members who have done or who contemplate woodcarving to bring along their work. Here is a chance to do some hands on work under top guidance.
- SCREEN PRINTING.** John Lathwell will bring along the equipment and will screen print items as required.
- SHOW AND TELL.** As a trial, Show and Tell has been brought forward to Saturday. Those who only attend on Saturday, PLEASE PARTICIPATE.
- VIC WOOD DEMONSTRATION VIDEO.** The video recorded by Brian Launer will be continuously on display from 10am Saturday for the benefit of those who where unable to see Vic "live".

**MANDURAH Accommodation Queries:** Jock McLean (095) 811686.

**COMPETITION WATTLE GROVE 16/17th JANUARY.  
ITEM: SQUARE EDGED BOWL.**

The competition year started with a couple of minor competition rule changes. Any number of entries will now comprise a class. So if you have taken the trouble to make the item required for the competition, you are assured it will be accepted and voted upon. The other change is to encourage people to use their votes – voting time has been brought forward to 12 noon on Saturday so that those who have to leave early will not miss voting. Because we had Vic Wood as our guest turner, most stayed all day Saturday so the changes were not needed on this occasion.

Nevertheless only 56 people voted out of approximately 150 present. Come on, please encourage the competitors and hone up your judging skills – Use those votes!!

The competition was for square edged bowls and once again we had a wide range of timber, skills and interpretations on display.

**RESULTS.**

- Beginners:** 1st Ken Locke, Midvale Group, Kauri Pine  
2nd Ted Cotgrove, Kenwick, Silky Oak  
3rd Elaine Boyd, Rockingham – Personia
- Intermediate:** 1st Bob Nichols, Midvale, Cape Lilac  
2nd Bob Holloway, N of R, Jacaranda  
3rd Eric Walker, Midvale, Jarrah
- Open:** 1st Alan France, Melville, Segmented Jarrah  
2nd Gordon Ward, Kenwick, Poplar  
3rd Viv Paust, N or R, Jacaranda

Alan France with yet another example of his beautiful segmenting work with inlay, won the Ladies Prize. Ken Rex took off the door prize. Congratulations to all placegetters, thank you very much to all competitors and don't forget – USE THOSE VOTES !!

**COMPETITION BRUNSWICK 20/21st February, 1993.  
ITEM: HOLLOW SPHERE ON STAND.**

Contrary to my opinion that the subject would be too hard, the number of entries was slightly up, never the less there still remains plenty of room for more competitors. The entries showed great ingenuity – spheres supported on spindles, tripods, swivel bases, hanging by string and also spirally askew.

There was only one entry in the beginners class and this gave us the opportunity to operate our new rule change and have this entry voted upon. Congratulations to Henry Walker. It is hoped that this will encourage more entries which was the spirit intended with the rule change. Viv Paust failed in his attempt to "build a better mouse trap". His offering had a cunningly concealed entry hole and three spikes inside to catch anything foolish enough to check out the interior, such as my little finger.

87 people voted, an increase which hopefully proves the value of opening voting at 12 noon and thus allowing more time.

**RESULTS.**

- Beginners:** 1st Henry Walker. Jacaranda.
- Intermediate:** 1st Bob Holloway. Camphor Laurel.  
2nd Bob Nichols. Jarrah.  
3rd Kevin Pritchard. Camphor Laurel.

- Open:** 1st Alan France. Jarrah and Aloes.  
2nd Viv Paust. Huon Pine/Sheoak/Jarrah.  
3rd Len Nicholls. Cape Lilac.

**Ladies Choice:** Alan France.

My congratulations to all involved in organising an excellent weekend. Well done Bunbury.

Eric Walker.

\*\*\*\*\*

**SHAVINGS FROM THE COMMITTEE.**

**Competitions.** There has been a marked increase in the number of votes for the monthly competitions since the change in the voting starting time from 2pm to midday. Whilst the membership survey showed an overwhelming preference for popular choice for judging the Association monthly competition, some support was given to judging by a panel. Occasionally therefore a panel will be used, particularly where competition items require measurement.

**Chuck Wagon.** The Committee has decided to buy a 2 wheel, braked and covered trailer to enable the currently heavily loaded "chuck wagon" to be relieved of some weight and to simplify its packing. This will widen the range of members cars that can easily tow these trailers and thus spread the task of towing over a greater number of volunteers.

**Competition Note.** In addition to the usual three category popular vote competition for WAWA members, there will be a separate Open competition at Denmark to be appraised by a joint panel of judges for a single prize to be awarded specially for this occasion. Denmark turners are invited to enter a piece for this competition and also WAWA members, who may use the piece they entered for the popular choice.

**Show and Tell Note.** All members are invited to bring along their best piece of turning so that others may view it and share in the appreciation of the achievement. This event will be conducted jointly by WAWA and the Denmark Turners. Please make a special effort to contribute so as to ensure its success.

**Newsletter.** The content and balance between the various items in the Newsletter is regularly under review. The need for adequate notice of coming events such as WE Workshop programmes is paramount. However, room is also needed for the many other elements that make up each issue. We think we may be able to squeeze in more short technical articles, but we can't increase the size of the Newsletter without a significant cost penalty. Perhaps members could give us their views on this matter.

**Demonstrators.** There have been a number of attempts recently, to update and expand the usefulness of our current list of accredited demonstrators. The last request to groups in September asked for details of demonstrators preferences, specialities and/or limitations so that the list would be more helpful to those making up monthly programmes. We have had a good response from one group, but little from the others. As it is in the interest of all WAWA members to have depth and variety in the programmes, you are asked to give some serious thought to what you can do to contribute and so ensure the vitality of our Association.

**SHAVINGS FROM THE COMMITTEE. Continued.**

**Management Changes.** As Mary and I will be moving back to Melbourne to live, this will be my last "Shavings" contribution. Also, I will be handing over the chairmanship of the WE Coordinating and Planning Committee to faithful and ever willing John Lathwell who will carry on until the AGM in September. At the AGM we will need someone to take John's place. After all his years of service he deserves a well earned break.

I take this opportunity to thank all those friendly members who have expressed so much good fellowship and to wish the Association continuing success. Gerald Young.

\*\*\*\*\*

**VOLUNTEER HANDS ON DEMONSTRATOR NEEDED.**

"The Come Out Camping for Older Adults" organisation needs a wood turner at their camps. Contact Gerald Young for details. (09) 399 5002.

\*\*\*\*\*

**HANDY TIP.**

When turning the interior of a bowl, try placing an elastic band around the exterior of the bowl, adjacent to the rim. (I cut mine from old car/truck tubes). This eliminates, or greatly reduces, the frustrating chatter or vibration that often occurs.

Alan France.

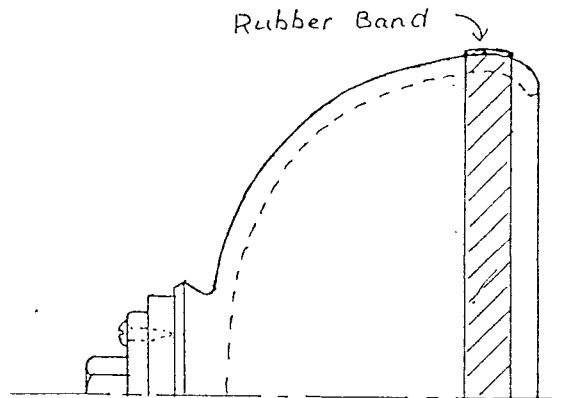

**A NATIONAL WOODTURNING COMPETITION/EXHIBITION AND SALE.**

A project to further the craft of woodturning in Australia.

29TH - 30TH MAY, 1993 AT NUNAWADING ARTS CENTRE, NUNAWADING, VICTORIA.

**SECTIONS.**

- |  |                                       |
|--|---------------------------------------|
| 1. Turned item with natural edge             | 2. Turned bowl - diameter up to 200mm |
| 3. Turned bowl - diameter greater than 200mm | 4. Turned platter                     |
| 5. Turned miniature or miniature set         | 6. Spindle turned item                |
| 7. Turned novelty item                       | 8. Pair of identical turned items     |
| 9. Turned item incorporating other materials | 10. Turned vase or hollow vessel      |
| 11. Turned lidded container                  | 12. Turned clock                      |
| 13. Laminated or built up turning (all wood) |                                       |

This is a premier event for woodturners throughout Australia and is open to all OPEN and NOVICE class woodturners. For this competition, a Novice is defined as a person who has never won a first prize in any woodworking competition.

For more information please refer to our February/March Newsletter No. 44.

This competition is being organised by YARRA TURNERS and FOREST HILL WOODTURNERS INC. If you would like further information, or to be included on the mailing list, please contact: Keith Towe (03) 457 2992 or Ted Anderson (03) 874 7365.

\*\*\*\*\*

**MEMBERSHIP SURVEY: MORE RESULTS.**

**Weekend Workshops. Attendance in twelve month period.**

Number:	Jan	Feb	Mar	Apr	May	Jun	Jul	Aug	Sep	Oct	Nov	Dec
%	13.5	13	6.5	5.5	4.5	13	9	6	3	13	6	7

**Venue Preferences:**

Country: 10%. Metropolitan: 15%. Both Country and Metropolitan: 75%.

**Social Activities:**

<b>Would stay for evening meal.</b>		<b>Would stay for social evening.</b>	
Country: 75%.	Metropolitan: 53%.	Country: 67%.	Metropolitan: 58%.

**Homestay:**

Would use: 18%. Would Offer: 42%.

**Newsletter: Universally popular and appreciated.**

- 48 members volunteered to write a letter/short article/tip or advice.
- 50% of respondents would like to see more articles.
- 70% of respondents would like more turner to turner issues.
- 30% of respondents would like more information on committee activities.

**Groups:**

- 30% of respondents in groups visit other groups.
- 58% state that companionship is a valued element of group membership.

### IDEAS FROM KURANDA, QUEENSLAND.

Kevin Hollioake would have to be our most distant member. Previously in Alice Springs, he recently moved to Kuranda (28 kms from Cairns). Kevin has five acres of which one is cleared and the remainder is beautiful rain forest. During the wet season he has to be careful going into the workshop for carpet snakes and pythons have a habit of hanging around the rafters. Mildew and rust are also a seasonal hazard. In meeting with other local turners Kevin tells of one who has a 13 foot pet python which keeps down the feral pigs and cats.

Despite the snakes, Kevin says any turners visiting the area are welcome to pop in - his phone number is: (070) 938931 or Box 560, Kuranda, Queensland. 4872.

Now for Kevin's tips on pens:

1. Pens are monogrammed using gold DECADRY lettering (10pt) 2.5mm. This is similar to letraset but cheaper and better and can be purchased from most stationery shops. The lettering is put on the black part of the clip and then covered with two coats of Rustins. The name is put on before assembling.
2. To cut the groove in the wood for the clip to fit, a burr is made up from a disused cigarette lighter. The flint wheel is removed and fitted to a 5/16 pop rivet nail. Grind a point on the nail, fit it into a Jacobs chuck in the head stock and use the tail stock to press fit the wheel on. (See drawing by John Lathwell).

### FLINT WHEEL FROM LIGHTER

use only solid flint wheels  
we coil type not useable.

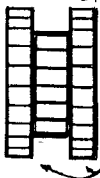

using pliers  
pull off  
thumb wheels  
and discard

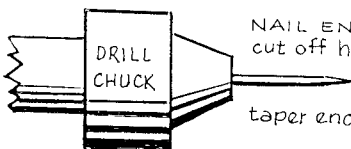

NAIL END  
cut off head

taper end with file

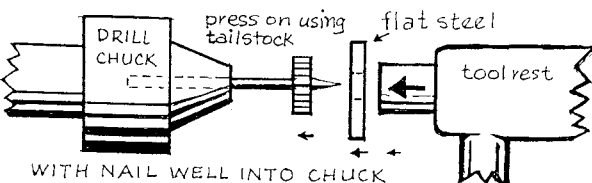

press on using  
tailstock

flat steel

tool rest

WITH NAIL WELL INTO CHUCK  
PRESS ON FLINT - USING FLAT STEEL PLATE  
WITH OVER SIZE HOLE ... THIS GIVES EVEN PRESSURE  
WHEN FORCED ON WITH TAILSTOCK.  
REMOVE POINT OF NAIL.

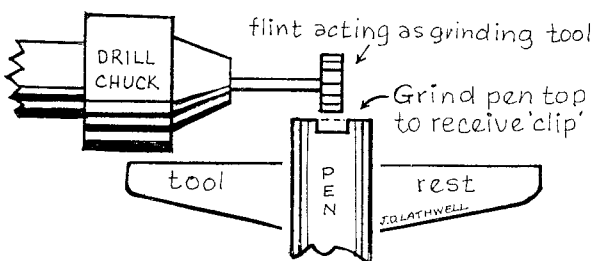

flint acting as grinding tool

Grind pen top  
to receive 'clip'

tool

PEN

rest

J. LATHWELL

3. If using square blanks, get an old socket from the tool box to make a 1/2" or 3/4" square drive by attaching it to a wooden plug for the screw cup chuck. (Again, see John Lathwell's drawing).

### HOW TO MAKE A SQUARE DRIVE CHUCK

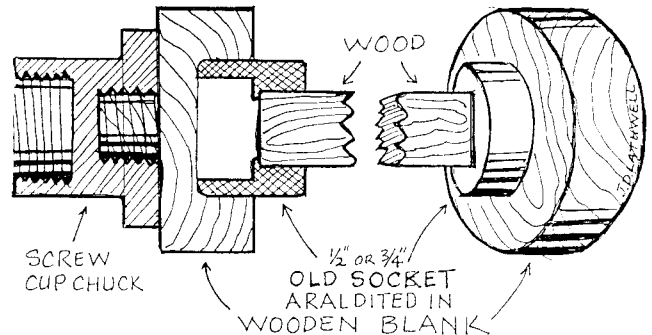

SCREW  
CUP CHUCK

WOOD

1/2" OR 3/4"  
OLD SOCKET  
ARALDITED IN  
WOODEN BLANK

Thank you Kevin for your very helpful and practical ideas.  
Happy turning with your new found rainforest timbers.

\*\*\*\*\*

### MULTI GRIP CHUCK by Woodfast.

Recently, I had the good fortune to win a Multi grip chuck, kindly donated by Woodfast S.A. The unit supplied was the basic model which operates in contraction mode only. Having used this device on a range of projects from various sized bowls to smaller jobs such as goblets, I have listed some features of this chuck for the benefit and appraisal of readers.

1. The back plate of the chuck has a screw centre facility to enable the exterior of the bowl/small project to be entirely completed.
2. The back plate has 4 holes drilled for wood screws which allows it to be used as a standard face plate.
3. Depending upon the bowl/project size, the chuck will hold the bowl foot (turned as an 8 degree spigot) in 32, 40, 50 or 65 mm diameters. Woodfast have provided a 4 step handy template to gauge spigot sizes accurately.
4. The spigot is very solidly held in 3 collet jaws tightened by a "c" spanner. When removing the project, the collet jaws automatically expand through the action of 3 spiral springs.
5. The chuck is machined to fine tolerances and the threaded collar is treated against corrosion.
6. A comprehensive instruction booklet is supplied which also lists accessories such as spur centres, screw cup chuck, screw spigot chuck and expansion mode collets which all go to make the complete unit a most versatile chuck indeed.

All in all I am most impressed and satisfied with the capabilities of the chuck. On some occasions, re-chucking was necessary, and each time, the job was held with no run-out seen.

\*\*\*\*\*

Alan France.

**AIR BRUSHING. CLASSES** for airbrush work, as applicable to wood, can be arranged by contacting JACKSONS, Beaufort Street, Perth. (09) 328 8880. Classes of 6 required.

## SAFETY HINTS.

**Don't be SHOCKED into getting rid of those old and DANGEROUS cords and appliances !!**

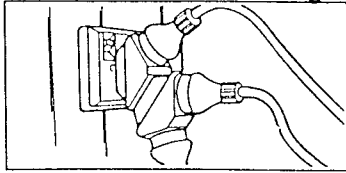

Never piggyback double adaptors

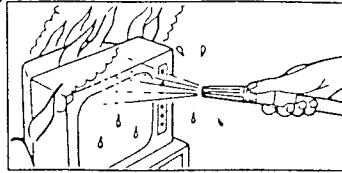

Never use water or foam extinguishers on electrical fires

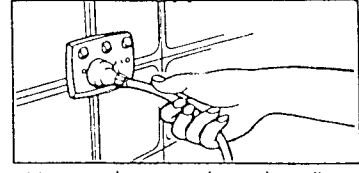

Never unplug an appliance by pulling on the power cord

Reproduced in part, with thanks to the Woodturners of the Hunter Co-operative Ltd.

### W.A.W.A. METROPOLITAN GROUPS MEETING TIMES, DATES AND VENUES.

MELVILLE. 4th Thursday 7.30pm Palmyra Recreation Centre, Cnr Murray Rd and Canning Hwy, Melville. 6156.

MANDURAH. Every 2nd Tuesday from 16th February, 1993 3pm Mandurah High School, Gibla Street, Mandurah 6210.

Check with Convenor for locations during school holidays.

MIDVALE. 1st Friday 7pm The Woodturning Centre, Stanhope Gardens, Midvale 6056.

MUNDARING. Every Friday except 1st in month. 7pm Venue about to change, check with Convenor first.

KENWICK. 1st and 3rd Wednesdays 7.30pm Liddlelow Homestead, Cooper Avenue, Kenwick 6107.

NORTH OF RIVER. 4th Tuesday 7pm Balga TAFE Campus, 18 Loxwood Road, Balga 6061.

AVON VALLEY. 3rd Thursday 7.30pm Venue. High School.

BUNBURY. 1st Wednesday, 3rd Friday 7pm. Cross Electrics.

BUSSELTON. 1st and 3rd Wednesday 7pm. Venue. High School.

COLLIE. Sundays 9.15am to 4pm. Various home workshops.

### WOODTURNERS ASSOCIATION OF W.A. (INC.) Committee and Convenors 1992/93

<b>PRESIDENT.</b> Jon Croft 98 Lewington Way Rockingham. 6168 Phone: 09 527 8048	<b>VICE PRESIDENT.</b> Gerald Young 34 Rails Crescent Wungong. 6112 Phone: 09 399 5002	<b>SECRETARY.</b> Neil Basden 14 Thurlow Avenue Yokine. 6060 Phone: 09 349 1082	<b>TREASURER.</b> Milton Rundle 26 Norbury Crescent City Beach. 6015 Phone: 09 385 9559	<b>PAST PRESIDENT.</b> Cyril Jones 6 Burt Court Dunsborough. 6281 Phone: 097 55 3606
<b>COMMITTEE.</b> Noel Moyes 25 Bentley Street Stoneville. 6554 Phone: 09 295 2281	<b>COMMITTEE.</b> Stan Gaston PO Box 8 Bindi Bindi. 6574 Phone: 096 54 3018	<b>COMMITTEE.</b> Neil Piper 20 Greenhood Crt Gosnells. 6110 Phone: 09 398 5290	<b>COMMITTEE.</b> John Lillywhite 35a Westbury Crescent Bicton. 6157 Phone: 09 339 2359	<b>COMMITTEE.</b> John Clark Lot 28 Bromley Rd Herne Hill. 6056 Phone: 09 296 4912
<b>COMMITTEE.</b> Max Hayles 34 Hannaby Street Dianella. 6062 Phone: 09 349 4125	<b>COMMITTEE.</b> Len Nicholls 68b Preston Point Rd East Fremantle. 6158 Phone: 09 339 6490	<b>CONVENOR (Melville)</b> Russ Russell 19 Mopsa Way Coolbellup. 6163 Phone: 09 337 7631	<b>CONVENOR(Bunbury)</b> Charles Pizzino PO Box 3 Donnybrook. 6239 Phone: 097 31 1034	<b>CONVENOR(Midvale)</b> John Lea 47 Gavour Road Wattle Grove. 6107 Phone: 09 453 2821
<i>Clare</i> <b>CONVENOR(Busselton)</b> Ray Batt 6 Bignell Drive Busselton. 6280 Phone: 097 52 1351	<b>CONVENOR(M/daring)</b> John Dillon 4 Westview Place Greenmount. 6056 Phone: 09 299 7125	<b>CONVENOR(C/Mid.)</b> Bill Proctor PO Box 302 Mpora. 6510 Phone: 096 51 1736	<b>CONVENOR(C/Sthn)</b> Jeff Nottle "Deloraine" Kweda Brookton. 6306 Phone: 096 42 7024	<b>CONVENOR(Tom Price)</b> <i>John Jones</i>
<b>CONVENOR(A/Valley)</b> Glyn Harrington Lot R56 W/Toodyay Rd Toodyay. 6566 Phone: 09 574 2129	<b>CONVENOR(Kenwick)</b> Dave Coney 47 Kelvin Road Maddington. 6109 Phone: 09 459 5702	<b>CONVENOR(Collie)</b> Fred Piavanini 2 Robb Street Collie. 6225 Phone: 097 34 1670	<b>CONVENOR(M/durah)</b> John McLean 102a Ormsby Terrace Mandurah. 6210 Phone: 09 581 1686	<b>CONVENOR(N of R)</b> Max Hayles 34 Hannaby Street Dianella. 6062 Phone: 09 349 4125
<i>Cheryl Russell</i> <b>MEMBERSHIP(Reg.)</b> Cheryl Russell 19 Mopsa Way Coolbellup. 6163 Phone: 09 337 7631	<b>PROPERTY.</b> Dig Constant 10 Clearview Avenue Mt Yokine. 6060 Phone: 09 349 7637	<b>SAFETY ADVISOR.</b> John Clark Lot 28 Bromley Road Herne Hill. 6056 Phone: 09 296 4912	<b>SHOP/C /SHOWS</b> (Co-ordinator) John Lillywhite Phone: 09 339 2359	<b>MONTHLY W/SHOP</b> (Co-ordinator) Gerald Young Phone: 09 399 5002
<b>VIDEO LIBRARIAN</b> Keith Stout 20 Currajong Road Duncraig. 6023 Phone: 09 448 2632	<b>EDITOR</b> Robin Halbert PO Box 941 West Perth. 6872 Phone: 09 322 2633 Fax: 09 321 1172			

**DON'T TERMINATE AN IDEA.  
GERMINATE AN IDEA!**

# WOODSTOCK

Timber Tools & Hardware PTY LTD

## TIMBER

201 Balcatta Road,  
Balcatta, W.A. 6021  
Phone: (09) 345 4522  
Fax: (09) 240 1014

PINE	MAHOGANY
JARRAH	TEAK
TAS OAK	AM RED & WHITE OAK
SHEOAK	EBONY
WANDOO	BLACKWOOD
TUART	MALAY KAURI
POPLAR	NYATOH
ASH	MERANTI
WALNUT	W.R. CEDAR
CHERRY	OREGON
JELUTONG	

## LATHES TOOLS

SAWS  
JAPANESE TOOLS  
SINGLEY DRUM SANDERS  
SHARPENING STONES  
WOODTURNING TOOLS  
WOODCARVING  
SPOKESHAVES  
PLANES

## CRAFT ACCESSORIES

39 KENT STREET  
CANNINGTON 6107  
TEL: 356 1653  
FAX: 321 4200



# Willetton Hardware

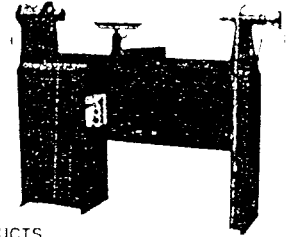

**PRODUCTS**  
Makita power tools, Triton work centre, Tough lathes, band saws, finishes, Woodfast lathes, clock movements, Sorby woodturning chisels, cutlery blanks, P&N woodturning chisels, barometers, thermometers, hygrometers.

**SERVICES**  
Saw and tool sharpening, key cutting. Open 7 days per week

**CONTACT** Philip R. Knowles  
**PHONE** (09) 457 8323  
**ADDRESS** 3/9 August St, Willetton WA 6155

W.A.'s



## WOODTURNING CENTRES



CROSS ELECTRICAL SUPPLIES  
90 BLAIR STREET, BUNBURY  
PHONE (097) 21 5858

THE WOODWORKING CENTRE  
14 STANHOPE GARDENS, MIDLAND  
PHONE (09) 274 5655

ALL YOUR NEEDS FOR:

## LEISURE ACTIVITIES WITH WOOD

WOOD LATHES: Tough, Woodfast, Teknatool, Durden, Vicmark

WE HAVE:

THE EQUIPMENT AND ASSOCIATED CRAFT ACCESSORIES  
CHISELS, BOOKS, VHS TAPES AND CAN ORGANISE YOUR LESSONS

## HAMERSLEY HARDWARE AND WOOD TURNING TOOL SUPPLIES

Tough, T/Gem	Mirothane
Woodfast	Mirowax, K36
Tekney Lathes	Shellac
Band Saws	Bees wax
P & N H/Taylor	Aqua putty
H/S Tools	1/2 & 5/8 Chucks
Grinders & Stones	No.2 Morse Tapers
Long Series Drills	

75 Eglinton Crescent  
Hamersley W.A. 6022  
Telephone: 448 1667

# W.A. TRADE TOOL CENTRE

UNIT 1 - 10 Pitt Way, Myaree.

## 330 3137

FOR ALL WOODTURNING SUPPLIES

SELECTION OF LATHES • BANDSAWS • SCROLLSAWS • BENCH GRINDERS • SORBY TURNING TOOLS • PFEIL CARVING TOOLS • LACQUERS & FINISHES • ENVIROTEX • CLOCK MOVEMENTS • LAMP FITTINGS AND VARIOUS ACCESSORIES  
ALSO SALES AND SERVICE FOR MOST MAJOR BRANDS OF POWER TOOLS

## SHARP TOOL SERVICE

- WOODFAST Lathes • Planers - Thicknessers - Sanders
- LEIGH Dovetail jigs • FREUD, RAPIER, AUSTSAW, Sawblades
- BORMAC Bandsaws • BANDSAW Blades made to size
- RYOBI, MAKITA Power tools • P & N Turning chisels
- CARBA-TEC Router bits • HEGNER Scroll saws
- FEAST WATSON Timber finish & stains
- Gift Vouchers • Hobbycraft Books
- SAW DOCTOR - Industrial, Hobbyist, Gardeners

25 Gympie Way  
WILLETTON W.A. 6155

Phone: (09) 457 7826  
FAX: (09) 354 3318

# T-Gem

## Wood Lathes

Australian Made  
3 Std sizes or to order

10" x 30" bc	Live Centre, Camlocks
16" x 36" bc	Hollow Tailstock
18" x 48" bc	Indexing, No2 Morse

Barnwell Engineering Developments  
5/2, James Street, BAYSWATER,  
W. A. 6053 Ph or Fax (09) 272 8033