

The Official Newsletter of the

THE  
**WOODTURNERS**  
ASSOCIATION OF WESTERN AUSTRALIA INC.

NO: 34

JUNE/JULY 1991.

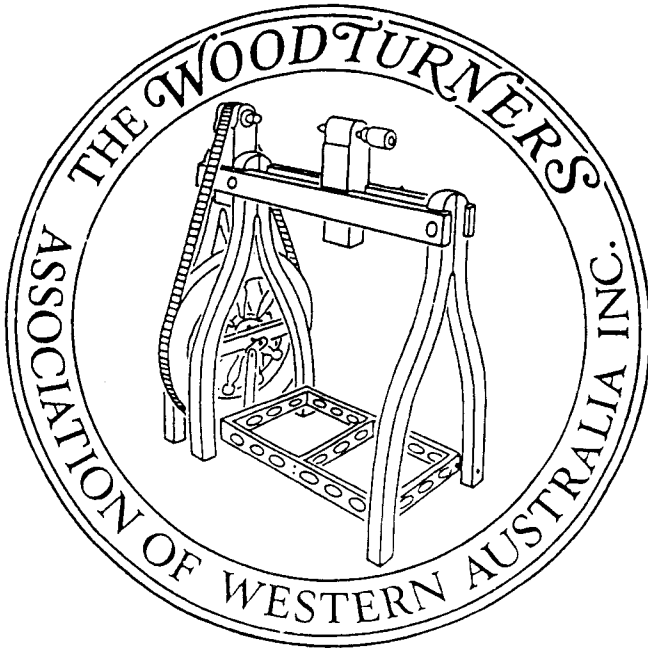

## MANAGEMENT COMMITTEE

### PRESIDENT

Cyril Jones  
6 Burt Court  
Dunsborough 6156  
097 55 3606

### SECRETARY

Nancy Launer  
Unit 7  
Busselton Gardens  
Busselton 6280  
097 52 3998

### TREASURER

Milton Rundle  
26 Norbury Crescent  
City Beach 6015  
(W) 09 265 3263  
(H) 09 385 9339

### VICE PRESIDENT

Bob Richards  
83 Glenig Avenue  
Wembley Downs 6019  
09 341 3235

### EDITOR

Geoff Barkla  
P.O. Box 115  
Kalamunda 6076  
09 293 4330

### ASST. EDITOR

Ivor Bridges  
4 Grancy Avenue  
Mundaring 6073  
09 295 1867

### COMMITTEE

John Lathwell  
22 Mary Drive  
Lesmurcie 6076  
09 291 6280

### COMMITTEE

Gordon Ward  
23 Hill Street  
Kelmscott 6111  
09 390 6418

### COMMITTEE

Bob Adams  
P.O. Box 2  
Coorow 6515  
099 52 3234

### COMMITTEE

Jim Clarke  
7 Peter Road  
High Wycombe 6057  
09 454 5337

### COMMITTEE

Brian Launer  
Unit 7 Busselton Gardens  
Busselton 6280  
097 52 3998

### MEMBERSHIP

#### SECRETARY

Cheryl Russell  
19 Mopsa Way  
Coolbellup 6163  
09 337 7631

### PROPERTY

Digger Constant  
10 Clearview Avenue  
Mt Yokine 6060  
09 349 7637

### VIDEO LIBRARIAN

Keith Stout  
20 Currajong Road  
Duncraig 6023  
09 448 2632

### GROUP LIAISON

Bob Richards

### SHOPPING CENTRE AGRICULTURAL SHOW COORDINATOR

Brian Launer

### MONTHLY WORKSHOP COORDINATOR

John Lathwell

## ASSOCIATION WEEKEND CALENDAR

<u>DATE</u>	<u>VENUE</u>	<u>COMPETITION</u>	<u>HOST GROUP</u>
June 15-16th	Belmont	Turned clock	Midvale
July 20-21st	Leederville	Vase Open unlimited Inter-up to 250mm Beginner-Budvase to 15mm	Kenwick
August 17-18th	Moora	Platter Open-up to 450mm Inter-up to 300mm Beginner-up to 200mm	Central Northern
September 21-22nd	Leederville	Pedestal Open-unlimited Inter-up to 750mm Beginner-up to 500mm	Executive

## PRESIDENT'S REPORT

One of the strengths of the Association has been the fellowship and sharing of skills, ideas, etc., of members. This was particularly evident at our recent meeting at Rockingham, when members of the Rockingham Woodworkers joined with us for the weekend. I am sure we not only exchanged a lot of ideas and skills, but we also learned more of our respective organisations. It was also very pleasing to have some of our members from Denmark (W.A.) with us. I hope they felt the journey for the weekend worthwhile. A more detailed report is found elsewhere in this Newsletter.

We are fast approaching that time of the year when we hold our Annual General Meeting and election of a number of positions on our Management Committee. You will find the relevant notices elsewhere in this Newsletter.

The Association has indeed been fortunate to have members who have had the interests of the Association high on their list of priorities. As the Association continues to grow it is important we continue to attract people with those interests. Many are not able, for various reasons to make any further commitment. Members should however give more than a little thought to the Association and its direction, as well as the people we elect to hold office. Take time to talk to others, and ensure we continue to have a Committee of the calibre we have had these past years.

CYRIL

### ANNUAL GENERAL MEETING NOTICE

Please take notice that the Annual General Meeting of The Woodturners Association of Western Australia (Inc.) will take place at Loftus Recreation Centre, Leederville on Saturday 21st September 1991 at 3.00 p.m.

Members are reminded that nominations for all positions that become vacant shall be on the appropriate form included with the June/July issue of the Association Newsletter. Also available from The Returning Officer by the 31st July 1991.

### XMAS IN JULY LUNCHEON - SATURDAY 6TH JULY 1991

Will be held at The Fremantle Sailing Club at \$15.00 per head - buy your own drinks  
Time: 12.00 noon until 3.00 pm. Ample parking and it is suggested you make it by 11.45 am.

Those wishing to attend MUST pay Verna Paust by Association weekend 15th & 16th June 1991.

---

### MEMBER HONOURED

One of our foundation members Wayne Mulholland received a Priory vote of thanks for his service to the Mullewa St. John Ambulance at the Investiture of The Most Venerable Order of the Hospital of St. John of Jerusalem. This award was presented by his Excellence the Hon. Sir Francis Burt, Governor of Western Australia at Government House on the 20th April 1991. Wayne is now at Wittenoom Caravan Park and would welcome a visit from his old woodturning mates.

# WOODTURNING ASSOCIATION OF WESTERN AUSTRALIA WEEKEND WORKSHOP MEETING.

SATURDAY 15TH & SUNDAY 16TH JUNE 1991.  
AT AUSTRALIAN AGRICULTURAL MACHINERY HOLDINGS  
73 ABERNETHY ROAD, BELMONT.

## SATURDAY:

- 9.00am Registration and fellowship. Hands On.  
Competition - Turned clock  
Running competition - wooden soldier  
Hands On - Outrigger Bowl turning - Ivor Bridges  
Blacksmith Demonstrations all day.
- 10.00am Morning Tea
- 10.30am Talk - Green turning, Keith Stout
- 11.00am Pantograph cutting and lettering - John Clark.  
LADIES - Ceramics with Gail.
- 12.00 noon L U N C H
- 1.00pm Table leg design and repetitive turning - Robert Mortimer
- 1.30pm LADIES - Hall Museum, Guildford
- 2.30pm Printing WAWA logo on aprons and tee-shirts - John Lathwell
- 3.00pm AFTERNOON TEA
- 3.30pm Tool sharpening, care and maintenance - Neal Tears of Sharp Tool Services.
- 6.00pm Evening meal - Casserole
- 7.00pm Talk by Karen Keely on 'Fine Woodworking & Handicrafts in the South West.'

## SUNDAY

- 8.00am Committee meeting
- 9.00am Registration and fellowship, hands on. Running Competition
- 9.15am Demonstration - Vase turning - Keith McQueen
- 10.00am MORNING TEA
- 10.30am LADIES - Doll Hospital and Museum, Guildford.  
Talk - Steps in and recommendations for furniture design, with particular reference to turned clock - Des Miller.
- 11.15am Talk - Bondcrete products  
Competition voting closes
- 12.00NOON Load Lathes etc.
- 12.15pm L U N C H
- 1.00pm Presidents Forum  
Competition results - Des Miller  
Show and Tell
- 3.00pm All Hands - Clean up.
- 

## SELLING THROUGH GALLERIES AND SHOWROOMS:

The Australian Government Publishing Service has produced a number of small books in their 'Managing the Small Business' Series. Five of these publications are of particular interest to craft practitioners.

**Selling It.** A guide to marketing for craft people

**Small Business AND The Law**

**Getting into Gifts** Starting and operating a Gift Shop

**Riding Your Brainwave** Marketing for Inventors and Innovators

**Marketing**

Please do not ring me but try: -Small Business Development Corp. 553 Hay Street (Cnr.) Pier Street.  
220 0229

**EDITOR GEOFF**

## Woodturners Association of W.A. Workshop/Meeting

Saturday 20th and Sunday 21st July 1991

Loftus Community Centre,

Cnr. Loftus & Richmond Streets, Leederville

### SATURDAY 20/7/91

- 8.30am Registration and fellowship  
10.00am Morning Tea  
10.30am Multiple centre turning - A. Malacari  
11.00am Talk on blackboy turning and finishing - E. Margetts  
11.30am Ladies. Glass etching by Rita Seaman. Bring glass items to be etched.  
12.00 LUNCH  
1.30pm Tool sharpening demonstration and talk - J. Shinnick  
2.00pm WOOD DUST What it can do to you and what to know about it - D. Gunn  
3.00pm Wood selection preparation - G. Ward  
4.00pm Hands on

During the day it is proposed to hold a silent auction of wood for turning. Members are asked to donate interesting pieces of wood for this auction. Proceeds to Bob Adams Tree Planting programme, a very worthy cause.

5.30pm Close - Tea - Casserole

7.00pm To be advised later

### SUNDAY 21/7/91

- 8.30am Registration - fellowship and hands on  
10.00am Morning Tea  
10.30am Demonstration. Tough lathe with right hand thread on outboard side. How to make the change - Keith McQueen.  
11.30am Hands on  
12.00 LUNCH  
1.00pm President's Report. Show & Tell. Competition results

**Weekend Competition.** During the weekend a lace bobbin competition will be run.

### EDITOR'S NOTES:

I would like first of all to say how much I appreciated your calls, cards and words of concern on my recent indisposition. I can assure each of you I am going along fine, am back for a few hours on the lathe and I am driving too. About another 5 - 6 weeks will see me right with no ill-effects.

Next I wish to say to those of you who purchased Gordon Weatherills machinery it all went very quickly and Betty joins me in thanking each of you and particularly Colin Kleining of The Woodworking Centre who disposed of it all so efficiently without claiming commission.

I have noted on occasions gaps in the programmes for workshops given to me for publishing in our newsletter. When I ask why, I find out that we are running short of NEW demonstrators, our old regulars are getting a bit tired of always being on call and I guess they get a bit embarrassed about being constantly on display. So how about it fellows and girls. We do need more participation and I don't mean only by attendance. Be in it, let out some of those special ways you make and do.

GEOFF

We have been advised that Greg Allen passed away peacefully on 15th April 1991. We express our sympathy to Mary.

## **FROM FOREST HILL WOODTURNERS INC. NEWSLETTER:**

In a recent issue of our Newsletter, I had occasion to reprint a news item about the dangers associated with arc welding and wearing contact lenses. Since then one of our members, Wolf Gartner, himself an optometrist, sent me ( from Singapore) an article which refutes this claim.

The article is culled from the March 1991 issue of 'Australasian Optometry, page 6. The item almost fills the entire page, however, I have reprinted below only that part titled 'AOA Press release'

### **A.O.A. Press Release**

Like a virulent virus, a medical myth is sweeping through Australian trade and professional work places, causing havoc in work sites.

Some factory Managers are so concerned about the 'safety' of their employees' sight that they are threatening to close down assembly lines.

The myth is an old one that surfaces regularly, particularly around April. This year it struck early. It claims that people who wear contact lenses and use welding equipment without protective eye goggles are in danger from microwaves generated by the electric arc.

The arc is supposed to fuse the contact lens to the surface of the eyeball the cornea is removed with it! Absolutely ridiculous and stupid said Joe Chakman, Executive Director of the A.O.A. It's like saying that when you remove your hat after a day in the sun your ears will come off. It is medically impossible for a sane person to pluck their own eyeball out of their head. Unless they deliberately lacerate the eyeball they cannot remove the cornea.

I cannot understand how responsible government departments such as the Department of Industry and Environment and Workcare are spreading this rumour in the workplace, said Joe. They are causing unnecessary hardship and fear in the workplace by threatening people's jobs. Together with some of the trade and professional journals, which picked up the story from the USA late last year, the Departments and their occupational health and safety managers are spreading unsubstantiated rumour of the worst kind.

The hoax has been traced back to a 1970 report in a Canadian Forests Products Ltd., Newsletter, which reprinted the story from an early edition of the 'Chicago Bridge' That paper reported a 1967 incident at the Bethlehem Steel Corporation Shipyard in Baltimore, USA, where an electrical switchbox blew up in the face of an employee, who was wearing contact lenses and safety glasses at the time, said Joe. He was treated for a corneal injury the next day and his vision returned to normal within a few days. The trade, professional and corporate media picked up the story and began publishing it in employee magazines and thats how the hoax started. Since then the US Food and Drug Administration, the American Optometric Association, the AOA Contact Lens Committee and various leading medical and research people have pointed out the ridiculous nature of the hoax.

I am really surprised that Departments, such as Workcare continue spreading it without reference to us, the Victorian College of Optometry or the Eye and Ear Hospital, even their own resident doctors, he said. This morning I was told that a Victorian Department of Industry report signed by the Chief Inspector of Mines and Quarries, Mr. F.O. Jones, was hanging on the notice board in a Kalgoorlie mine under the heading ' Significant Incident Report'. The only significant incident in this case is that sane, intelligent and educated people can be caught up in a hoax of this magnitude, Joe said.

## MELVILLE 16TH - 17TH MARCH 1991.

Ninety eight Members and fifty three Associates and visitors were present at the monthly weekend at Lofius Street. An extremely varied programme for both members and associates was presented by Harry Norman.

President Cyril Jones welcomed all and gave us good news re our old friend Edgar Lewis. He also extended good wishes to Elaine Boyd re her hand operation - no it was not a woodturning accident! We welcome Joan Barber home from St. Johns Hospital, Bunbury and hope she continues to improve in health.

Show & Tell was ably conducted by Keith Johnson, where ten of our Woodturners had diverse and interesting objects about which they share information.

The Candlestick Competition with twenty entrants divided among the three divisions was judged by Bill Botman and Bill Crow  
Results:

Beginners:	3rd Chas Owens	2nd Peter Blake	1st Kevin Pritchard
Intermediate:	3rd Viv Paust	2nd Cyril Jones	1st Bill Crow
Open:	3rd Ern Margetts	2nd Bill Botman	1st Len Nicholls
Ladies Choice	Harry Norman	Sheoak Candlestick	
Door Prize	Mr. Coopman from North of the River		

Know Your Wood      Guava 12 year old tree - No winner. There was only 1 entry - have a go people!

The ladies were well catered for with an especially delightful talk on budgies. The birds were really beautiful.

Saturday night went off with a bang with BINGO and all present enjoyed the barbecue beforehand. Looking forward to next meet.

---

## THORA

### MOORA WEEKEND 17TH - 18TH AUGUST 1991:

Accommodation:      St. James Hostel, Moora  
Contact Stan Gaston P.O. Box 8 Bindi Bindi 6574. Phone: 096 543018

Meals &	Bed:		
\$10.00	\$12.00	Friday	
\$28.50	\$12.00	Saturday	
\$14.50		Sunday	Total: \$77.00
Extra - Soup	Saturday \$1.00	Sunday \$1.00	Total \$79.00

---

### GUESSING THE WOOD COMPETITION - JON CROFT - Rockingham Workshop.

Timber Pittosporum Phillyredides

(Weeping Pittosporum or Desert Willow)

Finish Natural

Winner: Graeme Rhind - Denmark

How old      8 years

Wood submitted by Kevin Pritchard - Brookton

When Cut      January 91.

## ROCKINGHAM 20TH - 21 APRIL 1991:

A very successful weekend at a new venue! There were 115 members and 118 associates and visitors. Jon Croft as Convenor made us all feel very welcome as did the two Saturday hostesses - Maisie Coutts and Elaine Boyd. The latter also shared M.C. duties with Keith Johnson. Good fellowship was abound and nothing seemed too much trouble for anyone. That's what this Club is all about.

We had a beautiful Exhibition of the work the ladies had finished for the needy children next Christmas. Not that they were finished of course - sewing machine, needle and hands went ten to the dozen the whole weekend.

Competition bowls made a lovely display and Viv Paust took charge while Bill Botman was away.

Winners:

Beginners:	1st Len Kenny	2nd Lindsay Toop	3rd Elaine Boyd
Intermediate	1st John Lathwell	2nd Stan Gaston	3rd Viv Paust
Open	1st Gordon Ward	2nd Keith Seaman	3rd Bob Power
Ladies Choice	Gordon Ward Bowl		
Know Your Wood	Won by Graham Rhind from Denmark clever man!. There were quite a few entries this time too which pleased Jon.		
Door Prize	John McLean - Mandurah.		

Jim Clarke ran the Turn a Sphere Competition and he divided it into 4 categories: -

- A. The Biggest Viv Paust
- B. Roundest Gordon Ward
- C. Best Finish Ray Quadrio
- D. The Smallest Ron Smith

On Sunday, which was well attended, we had a talk by Reg Smitt from Rockingham on ideas on turning, shapes and general presentation. A lot of new ideas here with lovely examples.

Then Reg Mosley gave a talk on North West Woods. The display was excellent showing Mulga, Desert Oak, Beef Wood, Mineritchi, Quondong, Needle Bush, Curara, Kimberly Iron, Gibb River Gum, Mangrove, Meelong, Snake Wood and Sandalwood.

Viv Paust conducted The Show & Tell, which once again had many interesting pieces and information to be shared.

Well Rockingham !! A tremendous weekend with a little flurry from Cyclone Fifi to finish!

**THORA**

---

### ROCKINGHAM DEMOS:

Ron Goodsons Demo scalloped edge bowls drew a lot of attention.

John Lathwells demo on hot glue gun use, flew apart when he found just about everybody already knew all about it. He mentioned also briefly about the super chuck by Woodfast.

Inside out turning talk by Hugh Oliver was informative.

Band sawing with Gordon Ward was informative and timely, now we can all easily fold a saw blade. Rus Russell's showing of his adaptation and use of home made turning tools was inspiring. Russ gained most of his ideas from Gordon Wilkins who has been doing it his way for many years.

Bob Power in his usual way showed us how he did some very quick bowls.

**JOHN LATHWELL**



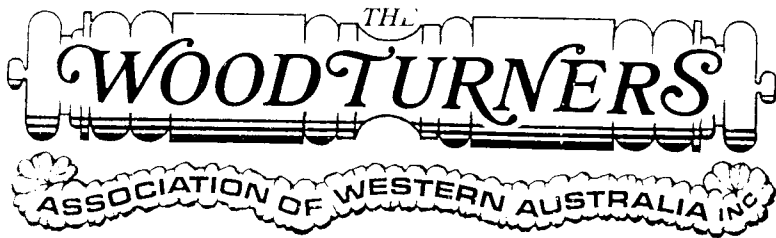

## ELECTION OF OFFICE BEARERS 1991/92

Notice is hereby given that the election for Office Bearers of the Association will be held at the Annual General Meeting to be held in conjunction with the Association's September 1991 Workshop. There is no postal, absentee or other form of voting.

The term of Office for the following members will expire at that Annual General Meeting.

President:	C. Jones
Committee Members:	I. Bridges
	B. Launer
	G. Ward
	Bob Adams
	V. Paust

The term of Office for President is one year while the term of office of the Committee Members is two years.

Any person wishing to nominate should complete the nomination form shown below and post it or deliver it to the returning Officer Mr. R. Leggo, 21 Williamson Way, Trigg. W.A., 6029 not later than 5pm on Wednesday 31st July 1991.

---

### WOODTURNERS' ASSOCIATION OF WESTERN AUSTRALIA NOMINATION FORM

I .....

of .....

wish to nominate myself for the position of \*President \*Committee member, to become vacant at The Annual General Meeting to be held in September 1991

Signed .....

Date .....

\*Cross out whichever does not apply.

**Nominations close with Returning Officer 31st July 1991.**

**Mr. R.L. Leggo, 21 Williamson Way, Trigg W.A. 6029**

# WOODSTOCK

201 Balcatta Road,  
Balcatta, W.A. 6021  
Phone: (09) 345 4522

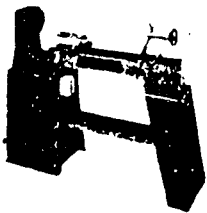

TANNER

- SPECIALITY TIMBER, PLANS, BOOKS, HERMLE
- P & N, SORBY, MARPLES, PFEIL, DAJTRA
- WOODFAST, T-GEM, TEKNA TOOL, DURDEN
- ECLIPSE, SANDVIK, STANLEY, FOOTPRINT
- ARBORTEC, DEADRIGHT CLAMPS, IRWIN SPEEDBOR
- CARBA-TEC, DRIMILL, SINGLEY, CONOVER, CLICO
- JAPANESE TOOLS, WILSTONES, HALLS ARKANSAS
- FULLER, DAVIS, FLEXOVIT, WOLFCRAFT

# TIMBECON Pty Ltd

1305 Albany Highway,  
Cannington, W.A. 6107  
Phone: (09) 356 1653



W.A.'s



## WOODTURNING CENTRES



CROSS ELECTRICAL SUPPLIES

90 BLAIR STREET, BUNBURY

PHONE (097) 21 5858

THE WOODWORKING CENTRE

14 STANHOPE GARDENS, MIDLAND

PHONE (09) 274 5655

ALL YOUR NEEDS FOR:

### LEISURE ACTIVITIES WITH WOOD

WOOD LATHES: Tough, Woodfast, Teknatool, Durden, Vicmark

WE HAVE:

THE EQUIPMENT AND ASSOCIATED CRAFT ACCESSORIES  
CHISELS, BOOKS, VHS TAPES AND CAN ORGANISE YOUR LESSONS

## W.A. TRADE TOOL CENTRE

UNIT 2, 8 PITT WAY, MYAREE

330 3137

FOR ALL WOODTURNING SUPPLIES

SELECTION OF LATHES • BANDSAWS • SCROLLSAWS • BENCH  
GRINDERS • SORBY TURNING TOOLS • PFEIL CARVING  
TOOLS • LACQUERS & FINISHES • ENVIROTEX • CLOCK  
MOVEMENTS • LAMP FITTINGS AND VARIOUS ACCESSORIES  
ALSO SALES AND SERVICE FOR MOST MAJOR BRANDS OF  
POWER TOOLS

# WOODTURNERS OF DENMARK (INC.) ANNUAL AWARD EXHIBITION:

Goundrey's Cellar Gallery  
12-17th January 1992.

## Categories:

1. Bowls 250mm diameter or above
2. Bowls below 250mm diameter
3. Lidded containers
4. Jewelry
5. Furniture includes Lamps and Clocks  
Entries must have a substantially turned component
6. Hollow turning and vases
7. Miniatures e.g. farm machinery, sporting equipment, household items, etc.
8. Miscellaneous - e.g. toys, mobiles, walking sticks, abstract etc.
9. Students 18 and under on December 31st 1991.  
Top mark for any single item. Students may also enter any other category not as a student
10. Popular vote  
Total limit of 2 entries per entrant in these combined categories.  
Entry forms and full details will be available in September.

CONTACT: Len Marshall - Promotions Secretary. P.O. Box 51, Denmark 6333. or (098) 481 421 if  
you require further details

---

## THE TREE'S PRAYER:

" Ye who pass by and would raise your hand against me,  
hearken ere you harm me.  
I am the heat of your hearth on the cold winter nights, the  
friendly shade screening you from the summer sun, and my  
fruits are refreshing draughts quenching your thirst as you  
journey on.  
I am the beam that holds your house, the board of your table,  
the bed on which you lie, and the timber that builds your boat.  
I am the handle of your hoe, the door of your homestead, the  
wood of your cradle, the shell of your coffin.  
I am the bread of your kindness and the flower of your beauty.  
Ye who pass by, listen to my prayer: Harm me not!"

The above prayer was printed on a plaque attached to an enormous specimen of a Tree of Heaven, in the Royal Tasmanian Botanical Gardens, Hobart. Early plantings in the garden date from 1815: from it's size, this tree could be one of them.

Reprinted with thanks to the Benalla Woodworkers Association Inc. Victoria.

---

## Newsletters received from kindred Organisations:

- Central Coast Woodturners Co-operative March 1991
- Forest Hill Woodturners (Inc.) April and May
- Woodturners of The Hunter Co-operative Ltd. No. 4 1991
- The Dubbo Woodworker April 1991
- Sydney Woodturners Guild April 1991
- South Australian Wood Group (Inc.) April, May 1991

LOCAL GROUPS

<u>BUNBURY.</u>	<u>PAUL HOLLIS</u>	<u>PH.097-959231</u>
<u>BUSSELTON.</u>	<u>BRIAN LAUNER.</u>	<u>PH.097-523998</u>
<u>CEN.MDLANDS.</u>	<u>STAN GASTON.</u>	<u>PH.096-543108.</u>
<u>CENT.SOUTHERN</u>	<u>RIC NOTTLE.</u>	<u>PH.096-427024.</u>
<u>COLLIE.</u>	<u>JOHN WALLACE.</u>	<u>PH.097-341209.</u>
<u>KENWICK.</u>	<u>DON GUNN</u>	<u>PH.09-3975851</u>
<u>MANDURAH.</u>	<u>RAY QUADRIO</u>	<u>PH.09-535275.</u>
<u>MU"VILLE.</u>	<u>HARRY NORMAN.</u>	<u>PH.09-3392409.</u>
<u>MIDVALE.</u>	<u>NOEL MYES.</u>	<u>PH.09-2952281.</u>
<u>MUNDARING.</u>	<u>KEITH LACY-HERBERT.</u>	<u>PH.09-5726097.</u>
<u>NORTHERN.</u>	<u>NEIL BASDEN.</u>	<u>PH.09-3491082.</u>

**For Sale**

River Banksia  
100mm slabs 300 to 600mm wide  
1.5m length  
John Bailey. Ph: 293 3125

**For Sale:**

14" Bandsaw as new  
Extension block & 2 new blades  
Stan Gaston - (096) 543018

**For Sale:**

Lathe Woodfast XK150 1 HP  
4 speed 3 tool rests.  
2 Tool posts Hollow Tailstock  
Pin Chuck McQueen Chuck  
1/2" Jacobs Drill Chuck Pen  
Mandrill \$1000 ONO.  
Brian Adams 295 4486 after  
4.00pm

**‘ARBORTECH POWER GOUGE’**

During my demonstration on bowl turning with the W.A.W.A. in Moora last year I made a comment to the effect that there must be an easier way to dispose of waste wood whilst woodturning.

As the days passed I thought of the answer and after several prototypes I succeeded in the development of an apparatus. After mentioning the presence of the development whilst demonstrating at last months W.A.W.A. workshop at Rockingham I have been contacted on a regular basis with queries regarding the matter.

As the registration of the Patent is now in place I can now inform the interested persons along with all members of the W.A.W.A. that the concept which has been developed by myself will be marketed by “ARBORTECH PTY.LTD” PERTH WA as the “ARBORTECH POWER GOUGE” and it will retail in the months to come at a realistic figure to suit the woodturner. I openly state that this concept will take woodturning into the 21st century and you the woodturner when you observe it in operation will be amazed as to the functions that it creates eg it will turn a 12" x 9" dry Jarrah burl into a bowl in under 15 minutes, softer timber eg. sheoak is a breeze for the unit. In fact it loves any timber presented to it.

At this stage I cannot because of obvious reasons elaborate on the construction of the gouge apart from stating it is of all steel and if treated with respect it will last you the tuner a lifetime, so please turners hang on, be patient, the answer to your turning dreams is just around the corner, till then happy turning.

**BOB POWER**

## HEALTH & SAFETY:

### Industrial Solvents.

Solvents are the most widely used chemicals in industry. Workers in many different jobs are regularly exposed to a variety of solvents which can have serious health effects. Workers employed in the printing, paints, plastics, petrochemicals, photographic, metal-working and building industries may be especially at risk.

### What are Solvents?

Industrial solvents are chemicals which can dissolve other substances. Industrial solvents are very useful because they can dissolve oil and grease, they can thin paints and resins, and are important in the manufacture of plastics, glues, inks and other chemicals. Thousands of common products used at work and at home contain solvents. Some typical products include degreasers, dry cleaning fluids, oil based paints, adhesives, typing correction fluids and pesticides.

### HOW DO SOLVENTS GET INTO THE BODY?

Solvents have both long and short term effects on the body.

Short term effects are caused by single exposures, often to a large amount of solvent. A very serious health effect of solvents is their anaesthetic effect. That is, they make you sleepy. With increasing over-exposure to solvents you will feel dizzy, drowsy, 'drunk' and may become unconscious. Over exposure can be fatal.

**Long term effects** result from frequent exposure, usually day after day, often to smaller amounts than are needed to produce short term effects. In the long term, solvents may effect:-

The brain and nervous system

The skin, causing dermatitis

The liver

**The blood-forming system**

The kidneys

The fertility of both men and women

The foetus

Some solvents can cause cancer, for example, benzene

### Tackling the problem.

The following control methods can be used.

The elimination of the most hazardous solvents, especially those that cause cancer.

**Safe handling** procedures should be adopted that prevent solvent vapours reaching the air, and which ensure that solvents do not come into contact with the skin. All solvent containers should have air-tight lids, and solvents should be pumped direct from one container to another rather than poured.

**The prevention of fire and explosion** by stopping any work, such as welding, in areas where solvent vapours may have built up. Any potential sources of ignition, such as welding in areas where solvent vapours may have built up. Any potential sources of ignition such as electrical wiring must be insulated.

**Effective exhaust ventilation** which removes mists or vapours from the air is a good way to prevent the inhalation of solvent vapours.

**Natural Ventilation** can be used to reduce exposures. Work in the open air is better than working in a closed room or semi enclosed space.

**Personal protective clothing** and equipment is important, but should never be used as the only method of control. Protective gear may include:-

Respirators

Specially woven and treated overalls

Gloves made from material which cannot be penetrated by solvent. This can be tested by hanging up the glove and filling it with solvent. See how long it takes for the solvent to come through. This will be the length of time you can safely wear the gloves.

Face shields with eye covering  
Aprons  
Gum boots

**Personal hygiene** is also important. Ensure that food is not eaten in solvent areas. **SOLVENTS SHOULD NEVER BE USED TO WASH OIL AND GREASE FROM HANDS.**

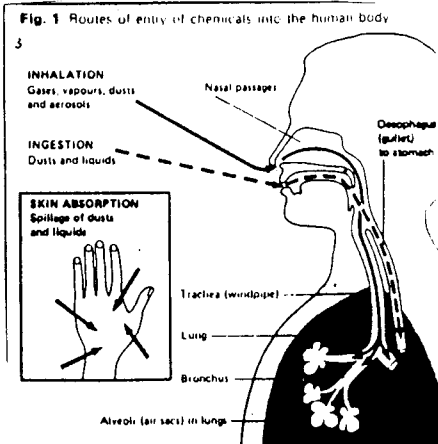

Acknowledgement is given to The Workers Health Centre, Lidcombe for the above information adapted by me from a larger article. In woodwork solvents are used in glues, lacquers and other finishing materials. A table showing the health effects of many common solvents will be in a later newsletter.

Our thanks to Mannie Burnham and The Sydney Woodturners Guild (Inc.)

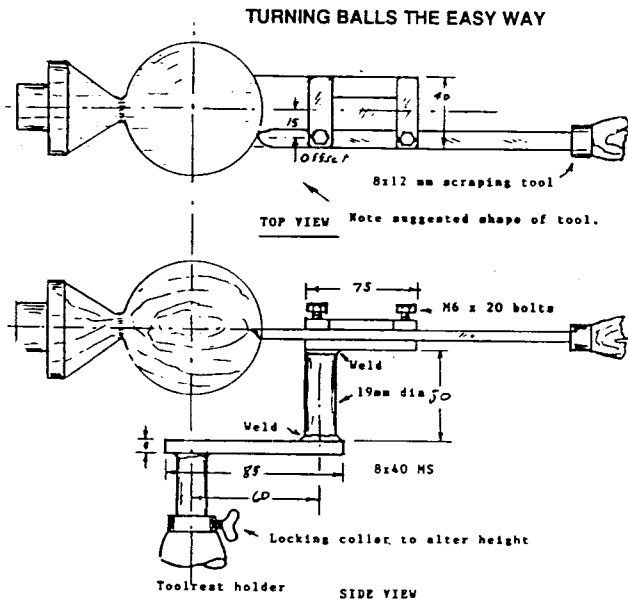

Mount stock in the cup chuck and rough turn the ball with a gouge. - Set the ball turning jig so that its pivoting axis is exactly below the middle of the ball. - Make sure the cutting edge is on centre height and take progressive cuts until the required diameter is achieved. - Sand and polish the ball before parting it off.

**OPEN 7 DAYS**

**" NEW " Mail Order Service**

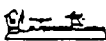
 Tough, Woodfast Lathes

Sorby Wood Turning Tools, Richard Raffin, Woodfast, Sorby Chucks. Electrical Fittings, Thermometers, Barometers Cutlery Blanks, Clock Movements, Finishes

**WILLETTON HARDWARE**

3/9 Augusta Street, Willetton, W.A. 6155

457 8323

**10% DISC**  
W.A. & N.S.W. Members (Specialists Excluded)

**HAMERSLEY HARDWARE AND WOOD TURNING TOOL SUPPLIES**

Tough, T/Gem	Mirothane
Woodfast	Mirowax, K36
Tekney Lathes	Shellac
Band Saws	Bees wax
P & N H/Taylor	Aqua putty
H/S Tools	1/2 & 5/8 Chucks
Grinders & Stones	No.2 Morse Tapers
Long Series Drills	

75 Eglinton Crescent  
Hamersley W.A. 6022  
Telephone: 448 1667

T-GEM T-GEM T-GEM T-GEM T-GEM

**T-GEM**

**WOODWORKING LATHES BUILT TO DO THE JOB**

Two models available.

Max Dia. over bed 406 457 4 speeds 500 1000 1700 3500  
Max Dia. outboard 660 760 Live centre: How low tail stock  
Between centres 914 1219 No. 2 Morse Tapers

**BARNWELL ENGINEERING DEVELOPMENTS**  
Unit 5, 2 James Street, Bayswater  
Western Australia 6053  
Phone (09) 272 8033 for details

T-GEM T-GEM T-GEM T-GEM T-GEM



**ALSO IN STOCK**

**TOUGH WOODFAST DURDEN LATHES**

SYMTEC  
Reproduce exact copies in both hard and soft wood

Call in for a hands on demo of the unique Symtec

**HUGH W. BROWN (AUSTRALIA)**  
1301 ALBANY HWY., CANNINGTON  
WESTERN AUSTRALIA 6107  
TELEPHONE 458 4488 FAX 451 6289

 **SHARP** **TOOL SERVICE**

- SAW DOCTOR •
- KITTY-woodworking machines • CARBATEC-router bits & wheel cutters • LEIGH-dovetail jigs • INCRA-jigs
- ISCAR-saw blades • HEGNER-scroll saws • RECORD MARPLES-chisels • HAKANSSON-bandsaw blades
- LIBERON-waxes • PFEIL-carving chisels • ARTEC-abrasives • Books • CRAFT TIMBERS

25 Gympie Way  
Willetton W.A. 6155

PH (09) 457 7826  
FAX (09) 354 3318

THE  
**WOODTURNERS**  
 ASSOCIATION OF WESTERN AUSTRALIA INC

**TOUGH**  
 TEL (09) 277 1166

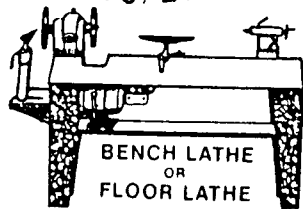

**The Ultimate in Professional Wood Turning Lathes**

ORDER NATIONALLY AT LEADING TURNING & POWER TOOL SHOPS.

**STANDARD EQUIPMENT:-** Cast Iron ■ Bed ■ Headstock ■ Camlock tailstock ■ 8" R.H. Face plate ■ 3/16" 24 index hole vee belt pulley ■ Matching motor pulley ■ 6" and 12" tool rests ■ Toolrest Bracket ■ Spanner ■ Spurdrive with removable point ■ Tailstock Centre with removable point.

**OPTIONAL EXTRAS:-** ■ Live tailstock cup centre ■ 24" Tool rest ■ Camlock tool rest bracket ■ Cup chuck ■ Pin chuck ■ 1/2" No 2 morse taper drill chuck ■ Three point steady ■ 8" & 6" Face plates with R.H. or L.H. threads. ■ 6" & 8" face plates universal (R.H. & L.H. threads) ■ Outrigger attachments ■ Sanding disc ■ 3" & 4 1/2" face plates with or without tapered screws ■ Deep drilling guide (fit tailstock) ■ Deep drilling attachment ■ Pre-drilled wood, centring points ■ 1 HP motor ■ Lathe stand.

Manufactured by  
**F. & R. TOUGH** PTY. LTD.  
 Ironfounders, Engineers & Toolmakers  
 BELMONT, WESTERN AUSTRALIA

**SURFACE  
 MAIL**

**POSTAGE  
 PAID  
 AUSTRALIA**

559  
 MR W.L. NICHOLLS  
 68B PRESTON POINT RD  
 EAST FREMANTLE  
 W.A. 6158

RETURN ADDRESS: P.O. Box 115, KALAMUNDA, W.A. 6076.

REGISTERED BY AUSTRALIA POST. PUBLICATION N° 1883